





FLATIRON STEEL

FLASHING DETAILS

3' TUF RIB / 3' DELTA RIB / 2' DELTA RIB

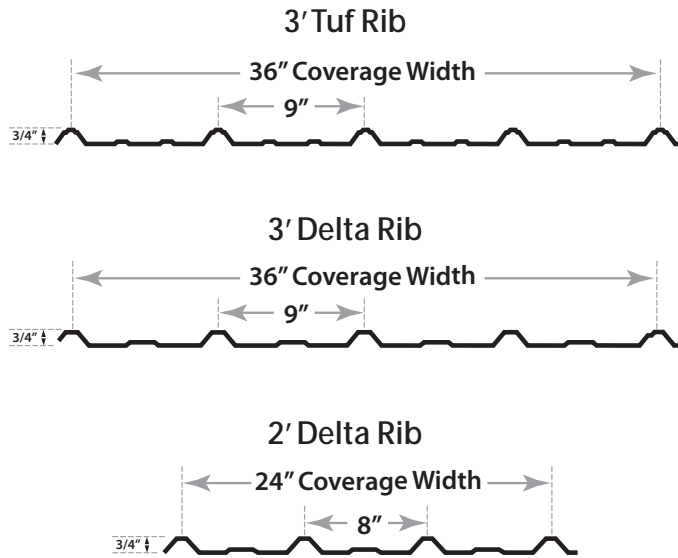

All specifications are designed to be used with panel profile heights of 3/4".

Each order is made specifically to match the needs of that particular customer. Standard trim is available in 10'2" and 12'0" lengths.

If needed, custom trim is available in all colors, 10'2" and 12'0" lengths, and will be priced based upon the desired profiles' girth (width before bending), and length.

Material used for 3' exposed fastener panels is typically made in 29 and 26 gauge material. It is available upon special request in 24 gauge.

Please call for details.

Flatiron Steel only stocks trim item numbers FS126A and FS126B. All other trim flashing is made to order.

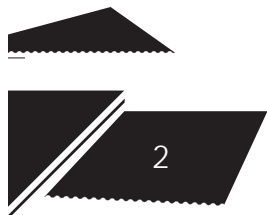

MATERIAL SPECIFICATIONS

29 Gauge -----

- Steel Yield Stress: 80,000psi (Grade E)
- Galvalume Steel Gauge, AZ - 55
- Paint System: Enviro Guard™
- 40-year warranty / Cool Roof Paint

26 Gauge -----

- Steel Yield Stress: 80,000psi (Grade E)
- Galvalume Steel Gauge, AZ - 55
- Paint System: Enviro Guard™
- 40-year warranty / Cool Roof Paint

COLOR OPTIONS

Contact Flatiron Steel to obtain color charts and samples.

COLOR	29 GAUGE	26 GAUGE	29 GAUGE 2' DELTA RIB
Galvalume	•	•	•
Cool White	•	•	•
Cool Parchment	•	•	•
Cool Light Stone	•	•	•
Cool Ivory	•		
Cool Beige	•		•
Cool Hickory Moss	•	•	
Cool Desert Brown	•		•
Cool Medium Brown	•		•
Cool Dark Brown	•		•
Cool Light Gray	•	•	•
Cool Dark Gray	•		•
Cool Hawaiian Blue	•		
Cool Dark Blue	•		•
Cool True Red	•		•
Cool Rustic Red	•		
Cool Burgundy	•		
Cool Medium Green	•		
Cool Dark Green	•	•	•
Cool Forest Green	•		•
Black	•		
Cool Copper Penny	•		

503 North 2nd Street | La Salle, Colorado | 970.284.6306



3' TUF RIB / 3' DELTA RIB / 2' DELTA RIB TRIM PROFILES

Rollformed Ridge Cap

Item #	Girth	Length	Weight
FS101A / FS101B	13 ¹ / ₈ "	10'2" / 12'	6.56 / 7.74 lbs.

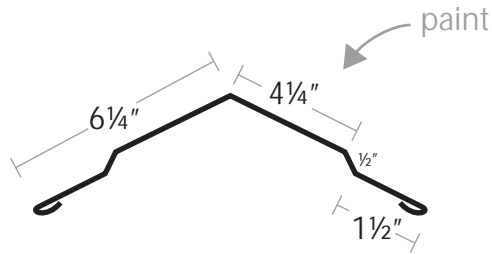

Sidewall

Item #	Girth	Length	Weight
FS104A / FS104B	9 ⁹ / ₁₆ "	10'2" / 12'	4.53 / 5.34 lbs.

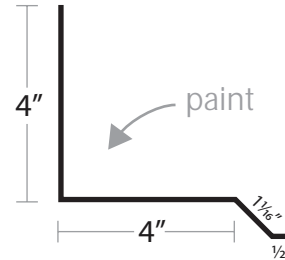

Gable / Rake

Item #	X	Girth	Length	Weight
FS102A / FS102B	4 1/4" (2x4)	10 1/4"	10'2" / 12'	5.13 / 6.05 lbs.
FS102C / FS102D	6 1/4" (2x6)	12 1/4"	10'2" / 12'	6.13 / 7.23 lbs.
FS102E / FS102F	8 1/4" (2x8)	14 1/4"	10'2" / 12'	7.13 / 8.40 lbs.

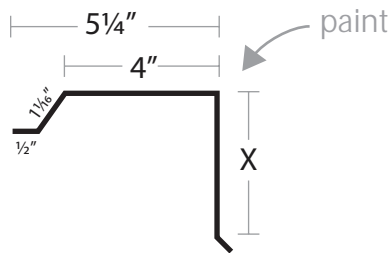

Endwall

Item #	Girth	Length	Weight
FS105A / FS105B	8 ³ / ₈ "	10'2" / 12'	4.19 / 4.95 lbs.

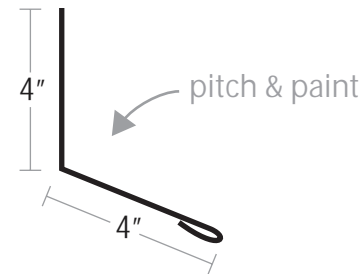

Eave (Style A Fascia)

Item #	X	Girth	Length	Weight
FS103A / FS103B	3 1/2" (2x4)	6"	10'2" / 12'	3.00 / 3.54 lbs.
FS103C / FS103D	5 1/2" (2x6)	8"	10'2" / 12'	4.00 / 4.72 lbs.
FS103E / FS103F	7 1/2" (2x8)	10"	10'2" / 12'	5.00 / 5.9 lbs.

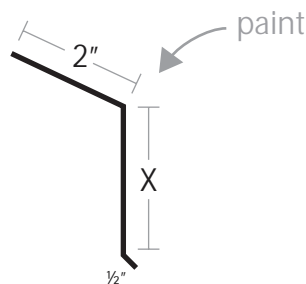

Rollformed Outside Corner

Item #	Girth	Length	Weight
FS106A / FS106B	12 ⁵ / ₈ "	10'2" / 12'	6.31 / 7.45 lbs.

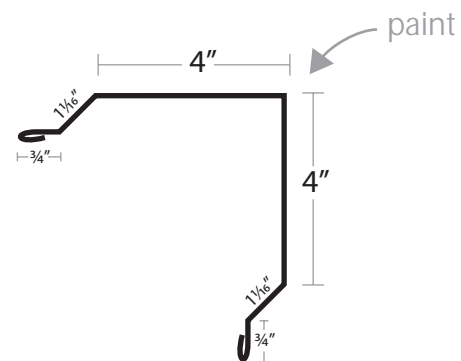

www.FLATiRONsteel.com

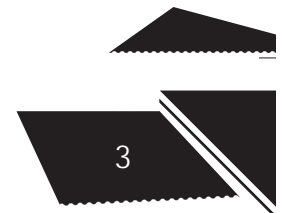



3' TUF RIB / 3' DELTA RIB / 2' DELTA RIB TRIM PROFILES

Rollformed Inside Corner

Item #	Girth	Length	Weight
FS107A / FS107B	1258"	10'2" / 12'	6.31 / 7.45 lbs.

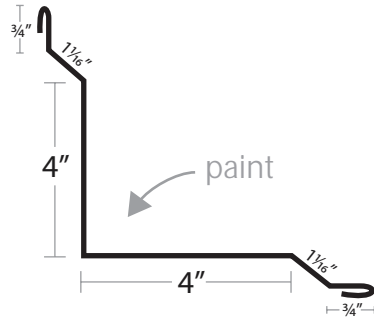

Door Post Trim

Item #	X	Girth	Length	Weight
FS110A / FS110B	3 1/2" (2x4)	5 3/4"	10'2" / 12'	2.87 / 3.39 lbs.
FS110C / FS110D	5 1/2" (2x6)	7 3/4"	10'2" / 12'	3.87 / 4.57 lbs.
FS110E / FS110F	7 1/2" (2x8)	9 3/4"	10'2" / 12'	4.87 / 5.57 lbs.

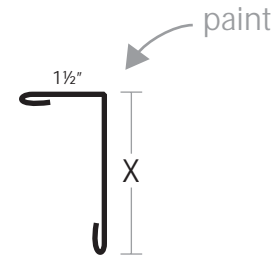

Upper Transition

Item #	Girth	Length	Weight
FS108A / FS108B	1238"	10'2" / 12'	6.19 / 7.30 lbs.

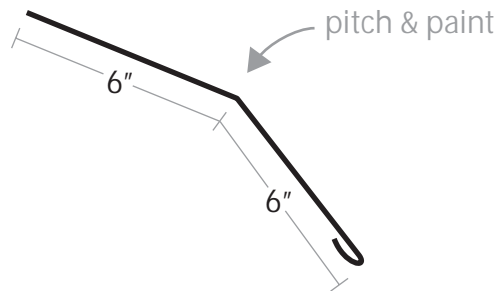

9 1/4" Door Jam

Item #	Girth	Length	Weight
FS111A / FS111B	958"	10'2" / 12'	4.81 / 5.68 lbs.

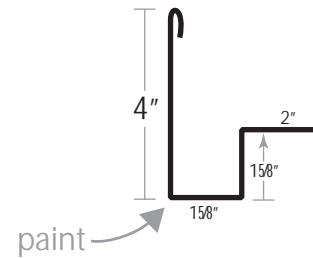

Lower Transition

Item #	Girth	Length	Weight
FS109A / FS109B	1238"	10'2" / 12'	6.18 / 7.30 lbs.

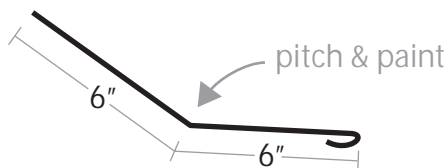

Overhead Door Trim

Item #	Girth	Length	Weight
FS112A / FS112B	11 1/2"	10'2" / 12'	5.75 / 7.08 lbs.

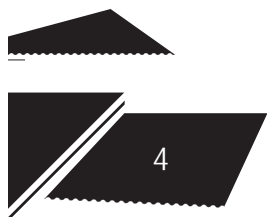
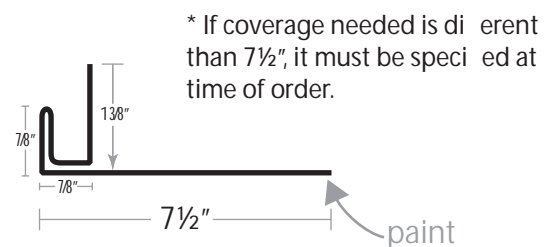

503 North 2nd Street | La Salle, Colorado | 970.284.6306





3' TUF RIB / 3' DELTA RIB / 2' DELTA RIB TRIM PROFILES

National Door Track Cover

Item #	Girth	Length	Weight
FS113A / FS113B	103/8"	10'2" / 12'	5.20 / 6.14 lbs.

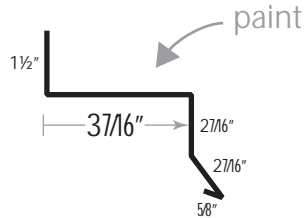

Style D Eave

Item #	Girth	Length	Weight
FS116A / FS116B	7.5"	10'2" / 12'	3.50 / 4.10 lbs.

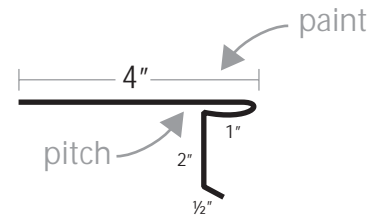

Combo Track Cover

Item #	Girth	Length	Weight
FS114A / FS114B	12"	10'2" / 12'	6.00 / 7.08 lbs.

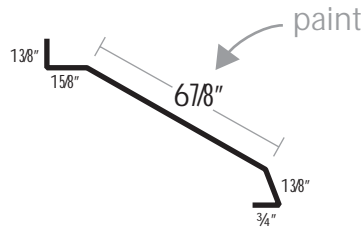

Front Cap (High Eave)

Item #	X	Girth	Length	Weight
FS117A / FS117B	4 1/4" (2x4)	10 1/8"	10'2" / 12'	5.10 / 6.00 lbs.
FS117C / FS117D	6 1/4" (2x6)	12 1/8"	10'2" / 12'	6.10 / 7.10 lbs.
FS117E / FS117F	8 1/4" (2x8)	14 1/8"	10'2" / 12'	7.10 / 8.30 lbs.

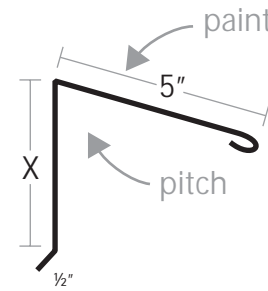

Top Mount Track Cover

Item #	Girth	Length	Weight
FS115A / FS115B	107/8"	10'2" / 12'	5.43 / 6.41 lbs.

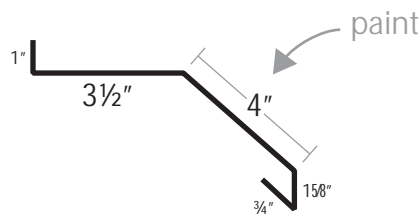

Snow Stop

Item #	Girth	Length	Weight
FS118A / FS118B	95/16"	10'2" / 12'	4.70 / 5.5 lbs.

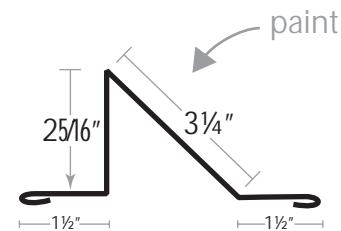

www.FLATiRONsteel.com

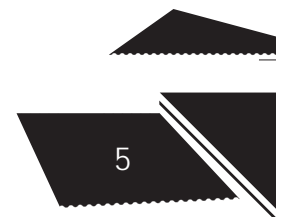



3' TUF RIB / 3' DELTA RIB / 2' DELTA RIB TRIM PROFILES

Z-Flashing

Item #	Girth	Length	Weight
FS119A / FS119B	37/8"	10'2" / 12'	1.90 / 2.30 lbs.

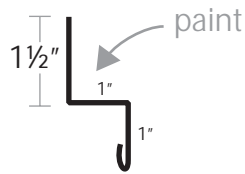

Square Base Trim

Item #	Girth	Length	Weight
FS122A / FS122B	43/4"	10'2" / 12'	2.40 / 2.80 lbs.

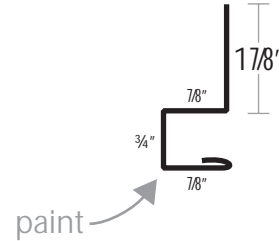

L-Angle (Channel)

Item #	Girth	Length	Weight
FS120A / FS120B		10'2" / 12'	

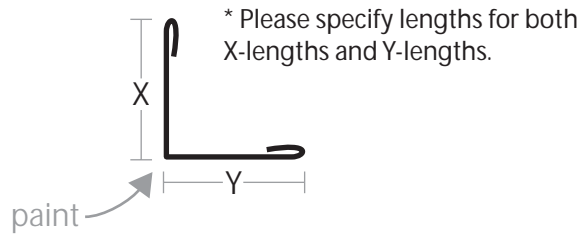

Z-Base Trim

Item #	Girth	Length	Weight
FS123A / FS123B	61/4"	10'2" / 12'	3.10 / 3.70 lbs.

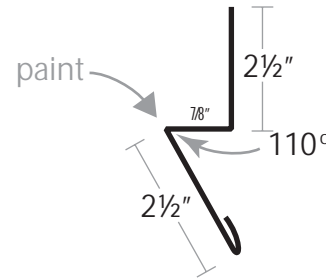

Window Drip Cap

Item #	X	Girth	Length	Weight
FS121A / FS121B	1"	33/8"	10'2" / 12'	1.60 / 1.99 lbs.
FS121C / FS121D	1 1/2"	37/8"	10'2" / 12'	1.90 / 2.30 lbs.

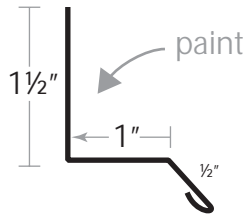

Rollformed J-Metal

Item #	Girth	Length	Weight
FS124A / FS124B	51/8"	10'2" / 12'	2.56 / 3.02 lbs.

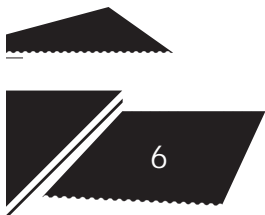
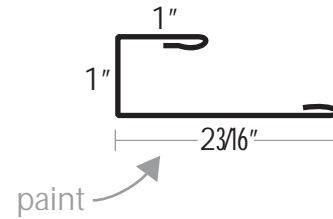

503 North 2nd Street | La Salle, Colorado | 970.284.6306





503 North 2nd Street | La Salle, Colorado 80645 | 970.284.6306 | www.flatironsteel.com

